

Scheinwerfer-Halter Light mounts

Montagehinweise

Alle vom Motorrad gelösten Schrauben sind gemäß Herstellerangaben wieder zu montieren, oder mit von SW-MOTEC gelieferten Schrauben zu ersetzen. Falls nicht anderweitig definiert, diese Schrauben nach Tabelle anziehen:

M6	9,6 Nm
----	--------

Gegebenenfalls Schrauben mit flüssiger Schraubensicherung einkleben.

Prüfen Sie nach 50 km alle Verbindungen auf festen Sitz.

**Technische Änderungen vorbehalten.
Irrtümer ausgenommen.**

SW-MOTEC GmbH & Co. KG
Ernteweg 8/10
35282 Rauschenberg
Germany

Tel. +49 (0) 64 25/8 16 8-00
Fax +49 (0) 64 25/8 16 8-10

info@sw-motech.com
www.sw-motech.com

Mounting Instruction

SW-MOTEC products should be installed by a qualified, experienced motorcycle technician. If you are unsure of your ability to properly install a product, please have the product installed by your local motorcycle dealer. SW-MOTEC takes no responsibility for damages caused by improper installation.

All screws, bolts and nuts, including all replacement hardware provided by SW-MOTEC, should be tightened to the torque specified in the OEM maintenance manual for your motorcycle. If no torque specifications are provided in the OEM maintenance manual, the following torques may be used:

M6	9,6 Nm
----	--------

All screws, bolts and nuts should be checked after driving the first 50 km to ensure that all are tightened to the proper torque.

Medium strength liquid thread-locker (i.e., "Locktite") should be used to secure all screws, bolts and nuts.

Subject to change. Not responsible for typos.

1 Anbaublech
Mounting Bracket



NSW.07.004.001

Anzahl/ Pcs. 1

2 Innensechskantschraube
Hexagon Socket Screw



M6 x 40 DIN 912

Anzahl/ Pcs. 2

3 Unterlegscheibe
Washer



A 6,4 DIN 9021

Anzahl/ Pcs. 2

4 Distanzbuchse
Spacer



Da:20 Di:6,4 h:9

Anzahl/ Pcs. 2

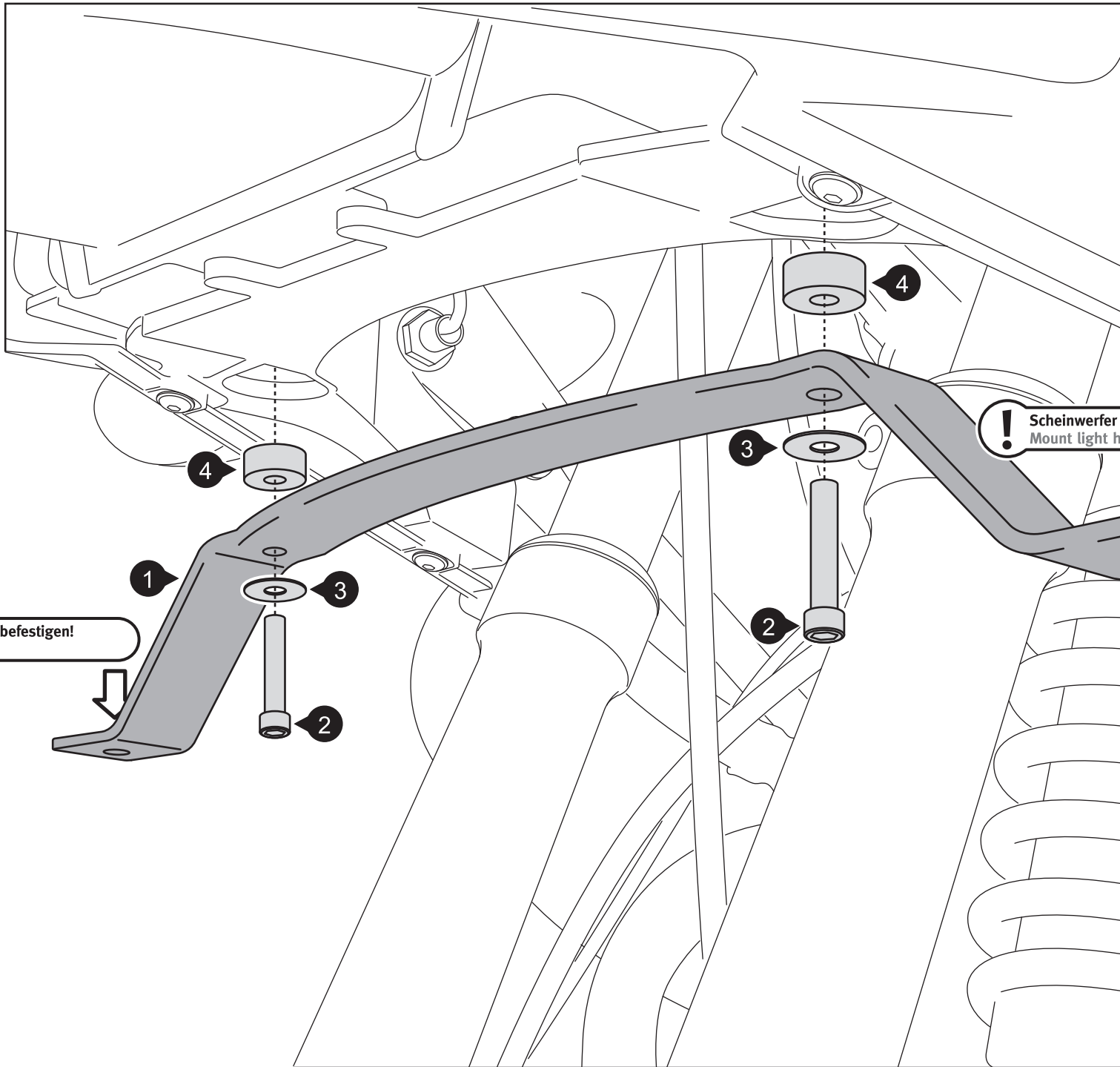
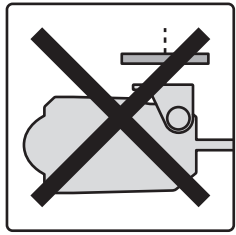
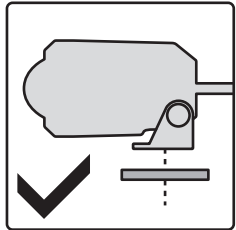

! Scheinwerfer hier befestigen!
Mount light here!

! Scheinwerfer hier befestigen!
Mount light here!