

COD. 15396-96

COD. 14699-96

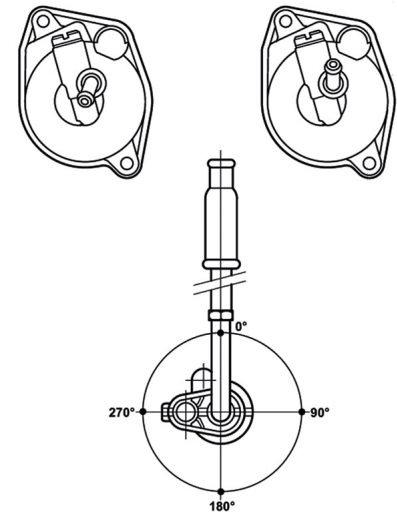

A

P

40

N°	Codice	Descrizione	Qta
0	03086	PHBN 12 HS	1
1	1524940 64	VALVOLA GAS	1
2	1368012 08	SPILLO CONICO A	1
3	14671209 28	POLVERIZZATORE GA	1
4	0641368 02	GETTO	1
5	1160032 02	GETTO	1
6	1477045 02	GETTO	1
7	1539400 53		1
8	5262000 77	BUSTA GUARNIZIONI	1
12	0752600 36	VITE	1
13	1505800 61	MOLLA	1
14	1368700 21	FERMAGLIO	1
15	1368100 21	ANELLO	1
17	0141100 61	MOLLA	1
18	1413000 37	VITE	1
19	5262000 77	BUSTA GUARNIZIONI	1
20	5308600 78	KIT VITE REG. VALVOLA	1
28	5262000 77	BUSTA GUARNIZIONI	1
29	5262000 77	BUSTA GUARNIZIONI	1
30	5300400 78	KIT STARTER A FILO	1
32	5305300 78	KIT GALLEGGIANTE	1
34	5262000 77	BUSTA GUARNIZIONI	1
35	5262000 77	BUSTA GUARNIZIONI	1
36	5262000 77	BUSTA GUARNIZIONI	1
38	1370900 36	VITE	2
40	1539600 96	VASCHETTA	1
41	5262000 77	BUSTA GUARNIZIONI	1