

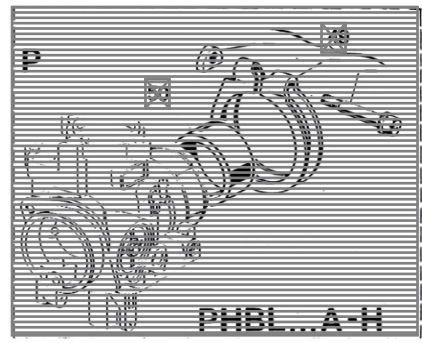

63

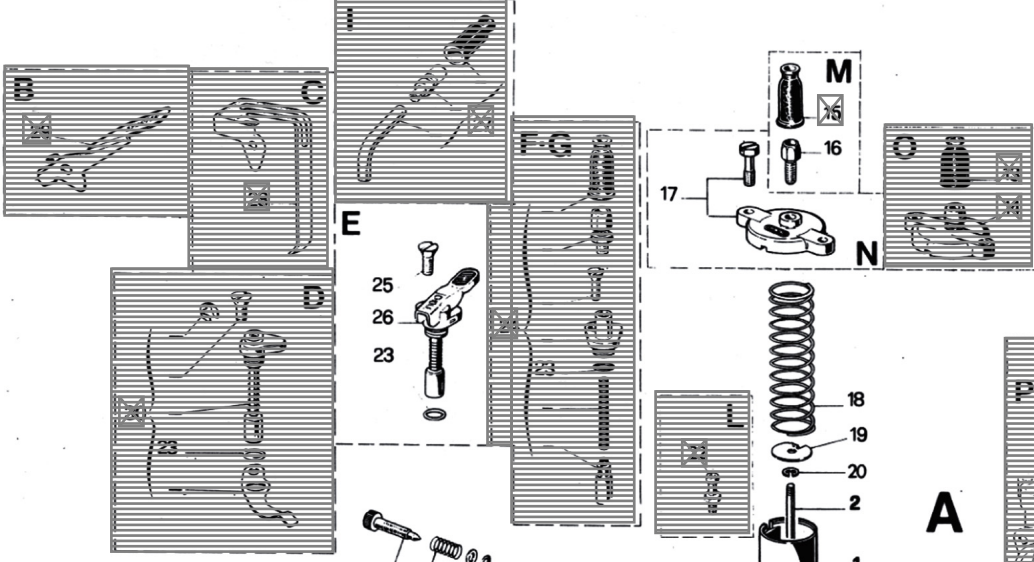

A

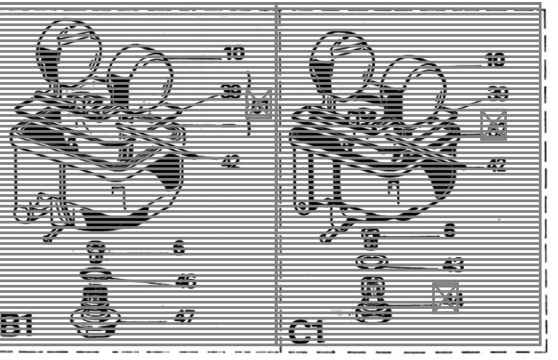
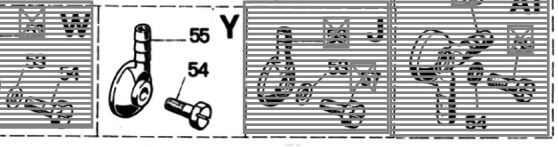
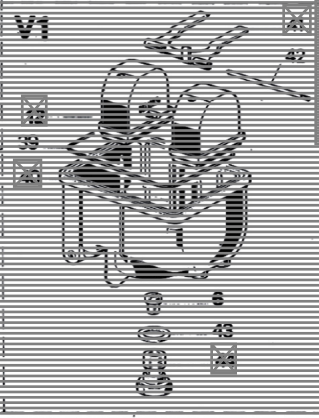
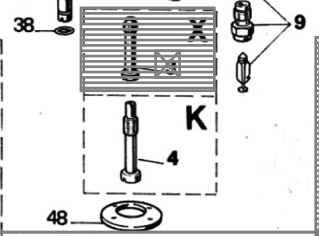
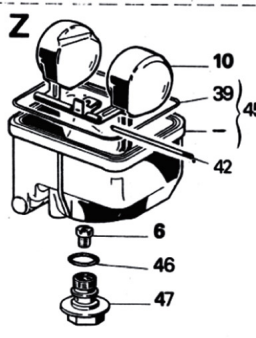
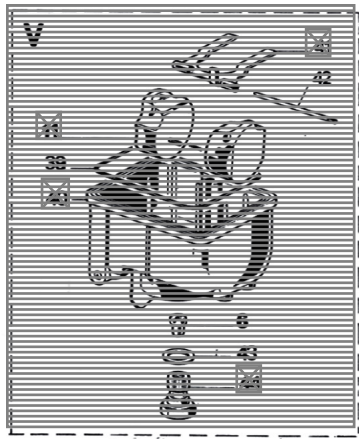
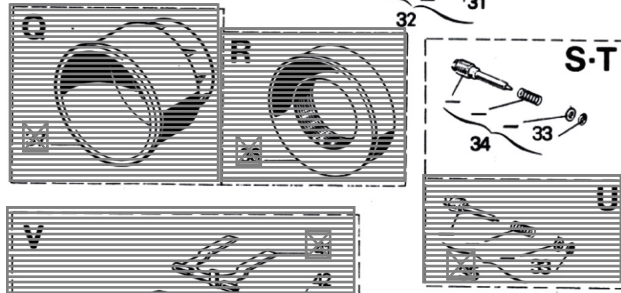

N°	Codice	Descrizione	Qta
0	02722	PHBL 22 BS	1
1	0964540 64	VALVOLA GAS	1
2	0226522 08	SPILLO CONICO D	1
4	09564264 28	POLVERIZZATORE AQ	1
6	0641390 02	GETTO	1
7	0148650 02	GETTO	1
8	0774660 02	GETTO	1
9	09436200 33	VALVOLA A SPILLO	1
9	10375200 33	VALVOLA A SPILLO	1
10	0901002 80	GALLEGGIANTE	1
16	0110400 37	VITE	1
17	5303300 78	KIT COPERCHIO VALV. GAS	1
18	0964400 61	MOLLA	1
19	0956300 21	PIASTRINA	1
20	0959600 21	FERMAGLIO	1
21	5252400 77	BUSTA GUARNIZIONI	1
23	5252400 77	BUSTA GUARNIZIONI	1
25	0774500 36	VITE	1
26	0829400 64	DISPOSITIVO AVVIAMENTO	1
31	5252400 77	BUSTA GUARNIZIONI	1
32	5302800 78	KIT VITE REG. VALV. GAS	1
33	5252400 77	BUSTA GUARNIZIONI	1
34	5302200 78	KIT VITE REG. MISC. MIN.	1
38	5252400 77	BUSTA GUARNIZIONI	1
39	5252400 77	BUSTA GUARNIZIONI	1
42	0734600 22	PERNO	1
43	5252400 77	BUSTA GUARNIZIONI	1
45	1378100 96	VASCHETTA	1
46	5252400 77	BUSTA GUARNIZIONI	1
47	1177100 34	TAPPO	1
48	0999600 52	FONDELLO	1
51	0610900 29	FILTRO BENZINA	1
53	5252400 77	BUSTA GUARNIZIONI	1
54	0456800 36	VITE	1
55	0925000 38	PIPETTA	1
60	5252400 77	BUSTA GUARNIZIONI	1
63	5252400 77	BUSTA GUARNIZIONI	1