

56

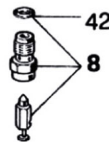

PHBE...H

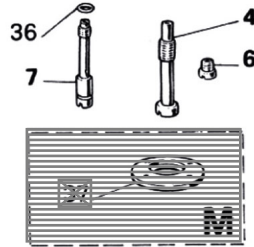
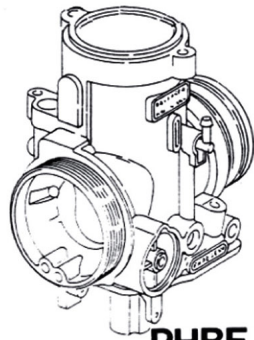
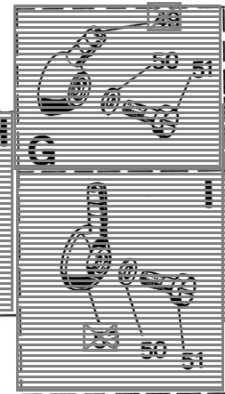
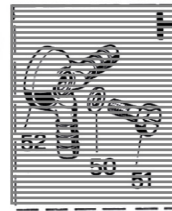
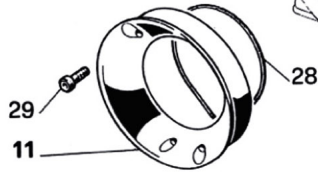
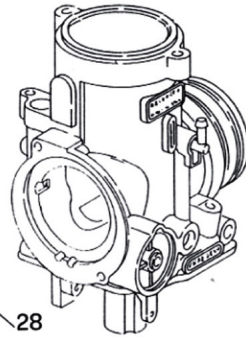

A

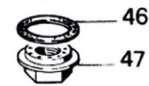
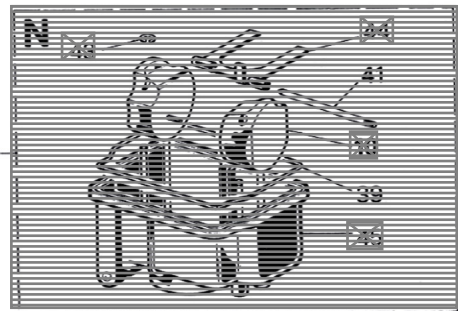
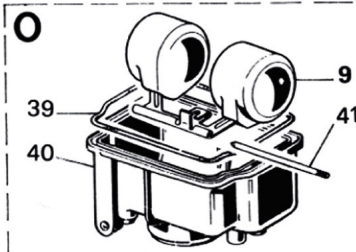
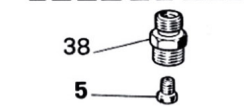

N°	Codice	Descrizione	Qta
0	06808	PHBE 30 HS	1
1	0930950 64	VALVOLA GAS	1
3	0853022 08	SPILLO CONICO K	1
4	08540270 28	POLVERIZZATORE AB	1
5	06413170 02	GETTO	1
6	0148668 02	GETTO	1
7	0774680 02	GETTO	1
8	08649250 33	VALVOLA A SPILLO	1
9	0745001 80	GALLEGGIANTE	1
11	1029530 82	RACCORDO	1
12	0774500 36	VITE	1
13	0829400 64	DISPOSITIVO AVVIAMENTO	1
14	5254600 77	BUSTA GUARNIZIONI	1
16	0854200 36	VITE	2
18	0110400 37	VITE	1
20	0855000 61	MOLLA	1
21	0852500 21	FERMAGLIO	1
23	1104500 53	COPERCHIO CAMERA MISC.	1
27	5254600 77	BUSTA GUARNIZIONI	1
28	5254600 77	BUSTA GUARNIZIONI	1
29	0904200 36	VITE	2
32	5302200 78	KIT VITE REG. MISC. MIN.	1
33	5254600 77	BUSTA GUARNIZIONI	1
34	5254600 77	BUSTA GUARNIZIONI	1
35	5302800 78	KIT VITE REG. VALV. GAS	1
36	5254600 77	BUSTA GUARNIZIONI	1
38	0888500 32	PORTAGETTO	1
39	5254600 77	BUSTA GUARNIZIONI	1
40	1055700 96	VASCHETTA	1
41	0734600 22	PERNO	1
42	5254600 77	BUSTA GUARNIZIONI	1
46	5254600 77	BUSTA GUARNIZIONI	1
47	1023800 34	TAPPO	1
48	0610900 29	FILTRO BENZINA	1
50	5254600 77	BUSTA GUARNIZIONI	1
51	0456800 36	VITE	1
52	0789000 38	PIPETTA	1
56	5254600 77	BUSTA GUARNIZIONI	1