

A

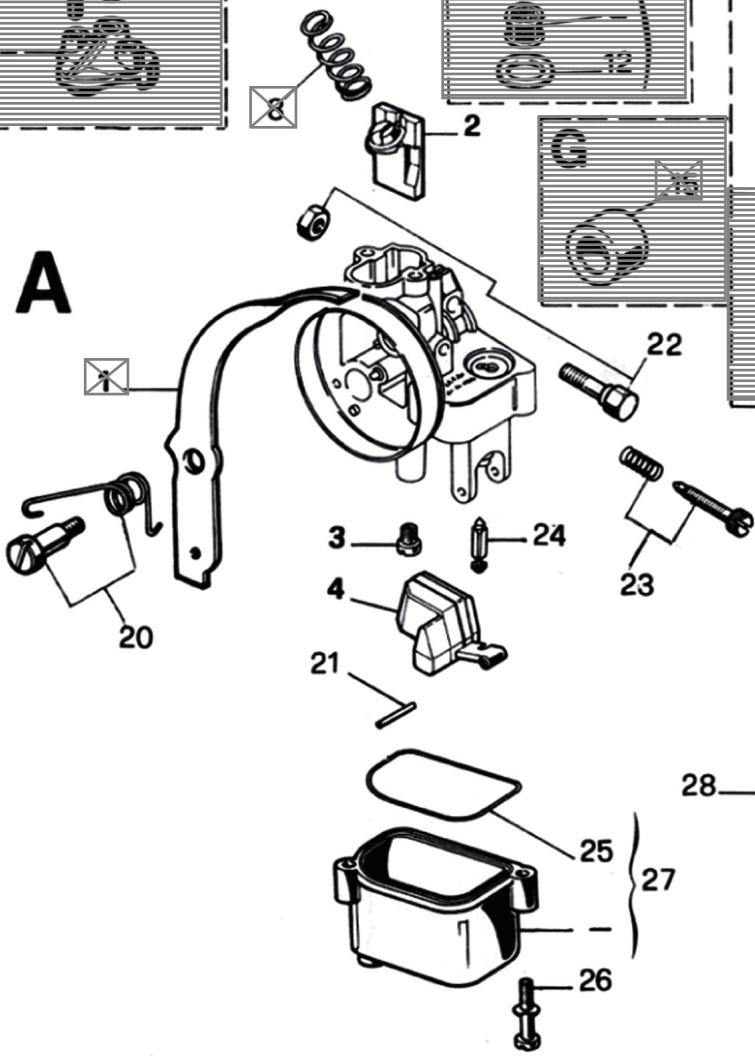

N°	Codice	Descrizione	Qta
0	02260	SHA 12 12	1
2	0740506 64	VALVOLA GAS	1
3	0148649 02	GETTO	1
4	0742001 80	GALLEGGIANTE	1
5	0811000 36	VITE	2
6	5254000 77	BUSTA GUARNIZIONI	1
7	1063800 53	COPERCHIO VALVOLA	1
11	5254000 77	BUSTA GUARNIZIONI	1
12	5254000 77	BUSTA GUARNIZIONI	1
14	5304700 78	KIT PIPETTA	1
16	5254000 77	BUSTA GUARNIZIONI	1
17	1136100 62	RIDUZIONE ISOLANTE	1
18	5254000 77	BUSTA GUARNIZIONI	1
20	5304600 78	KIT PERNO VALVOLA ARIA	1
21	0456000 22	PERNO	1
22	5304800 78	KIT VITE SERR. MANICOTTO	1
23	5303000 78	KIT VITE REG. VALV. GAS	1
24	0283800 05	SPILLO CHIUS. BENZ.	1
25	5254000 77	BUSTA GUARNIZIONI	1
26	1183700 36	VITE	2
27	1350300 96	VASCHETTA	1
28	5254000 77	BUSTA GUARNIZIONI	1

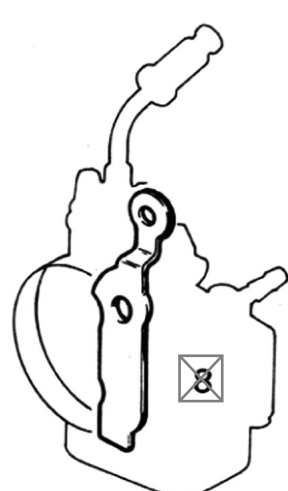
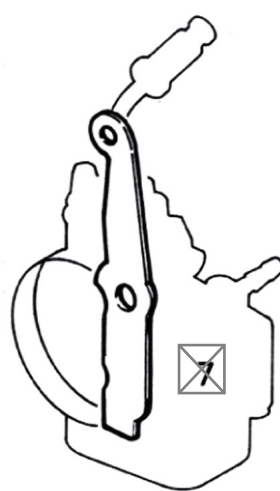
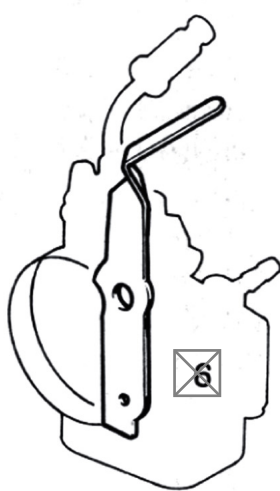
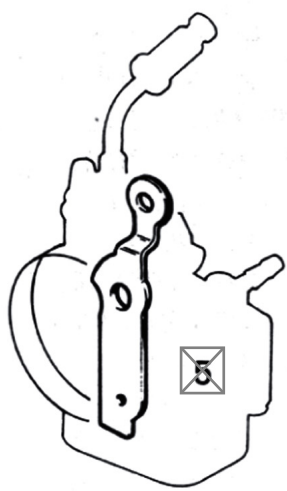
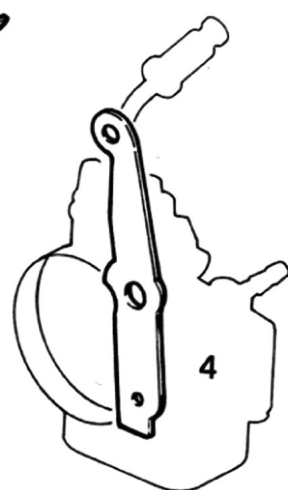
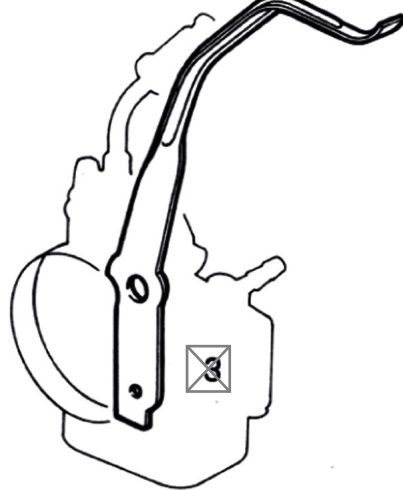
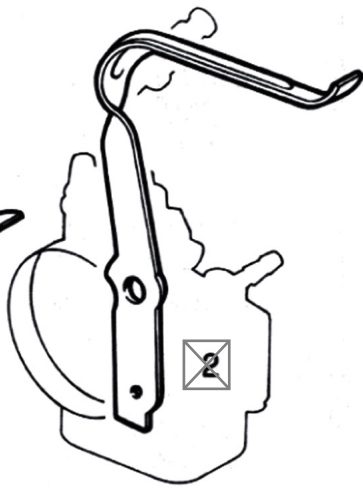
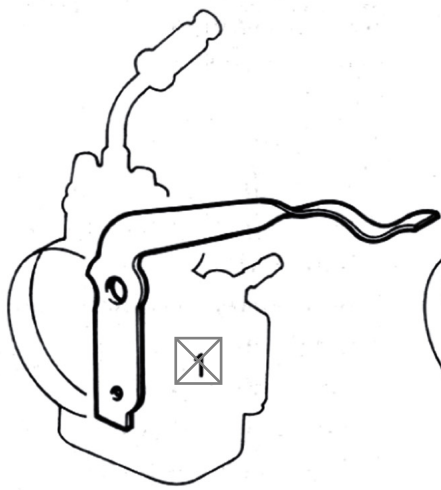

N°	Codice	Descrizione	Qta
4	0989113 64	VALVOLA ARIA	1