

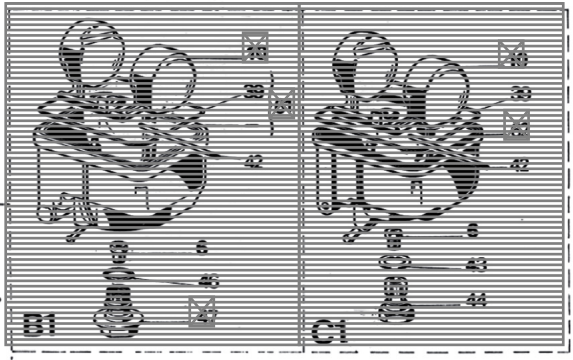

63

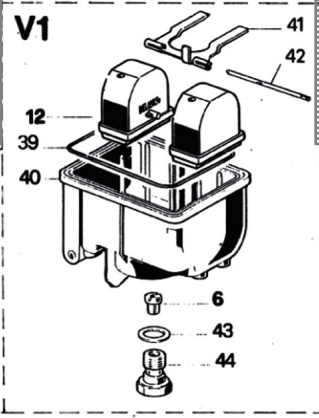
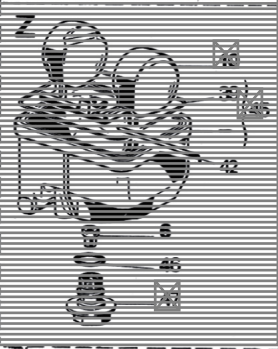
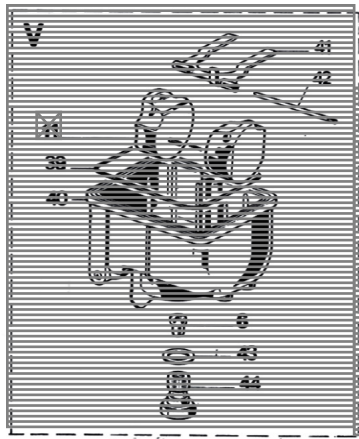
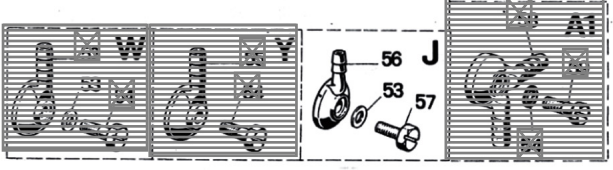
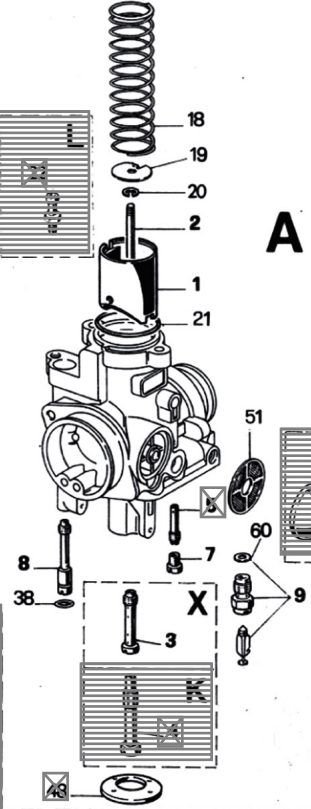
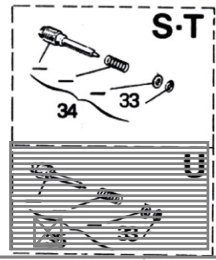
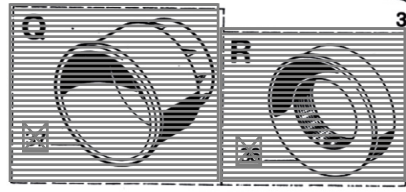
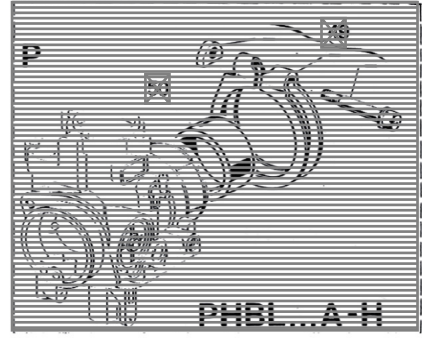
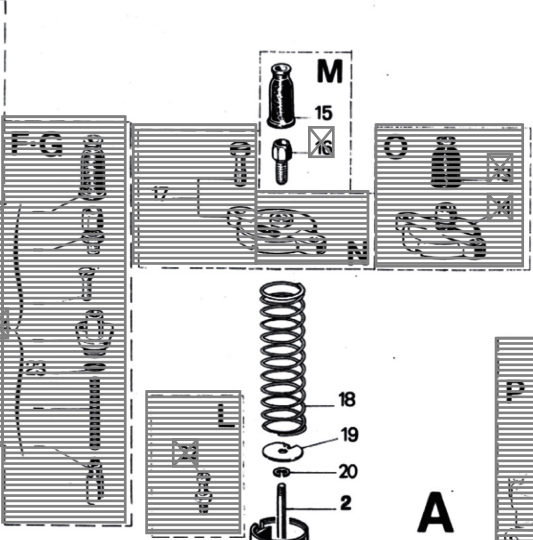
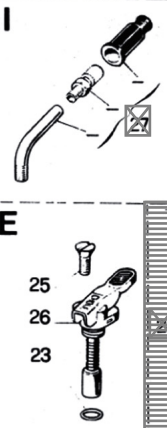
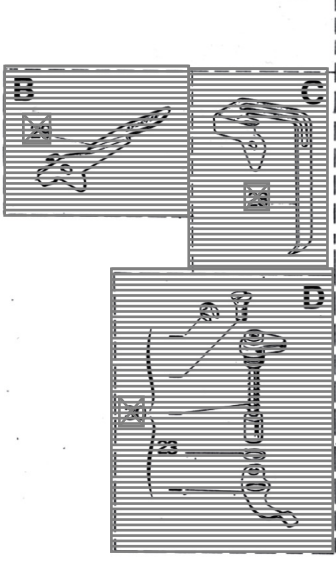

N°	Codice	Descrizione	Qta
0	02854	PHBL 26 BS	1
1	0964560 64	VALVOLA GAS	1
2	0226536 08	SPILLO CONICO D	1
3	08358270 28	POLVERIZZATORE K	1
6	06413110 02	GETTO	1
7	0148630 02	GETTO	1
8	0774660 02	GETTO	1
9	08649250 33	VALVOLA A SPILLO	1
12	1576005 80	GALLEGGIANTE	2
15	1137700 06	CAPPUCCIO	1
17	5303300 78	KIT COPERCHIO VALV. GAS	1
18	0964400 61	MOLLA	1
19	0956300 21	PIASTRINA	1
20	0959600 21	FERMAGLIO	1
21	5252400 77	BUSTA GUARNIZIONI	1
23	5252400 77	BUSTA GUARNIZIONI	1
25	0774500 36	VITE	1
26	0829400 64	DISPOSITIVO AVVIAMENTO	1
31	5252400 77	BUSTA GUARNIZIONI	1
32	5302800 78	KIT VITE REG. VALV. GAS	1
33	5252400 77	BUSTA GUARNIZIONI	1
34	5302200 78	KIT VITE REG. MISC. MIN.	1
38	5252400 77	BUSTA GUARNIZIONI	1
39	5252400 77	BUSTA GUARNIZIONI	1
40	1359000 96	VASCHETTA	1
41	1315400 26	BILANCIERE	1
42	0734600 22	PERNO	1
43	5252400 77	BUSTA GUARNIZIONI	1
44	0626700 34	TAPPO	1
46	5252400 77	BUSTA GUARNIZIONI	1
51	0610900 29	FILTRO BENZINA	1
53	5252400 77	BUSTA GUARNIZIONI	1
56	0875200 38	PIPETTA	1
57	0405300 36	VITE	1
60	5252400 77	BUSTA GUARNIZIONI	1
63	5252400 77	BUSTA GUARNIZIONI	1