

A

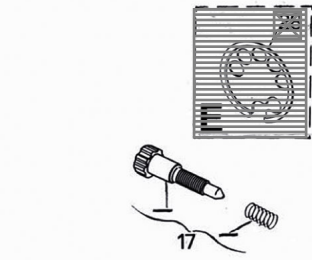

COD. 15548-96
COD. 15354-96

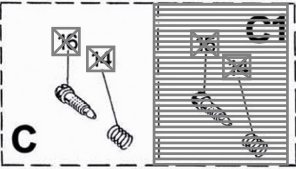
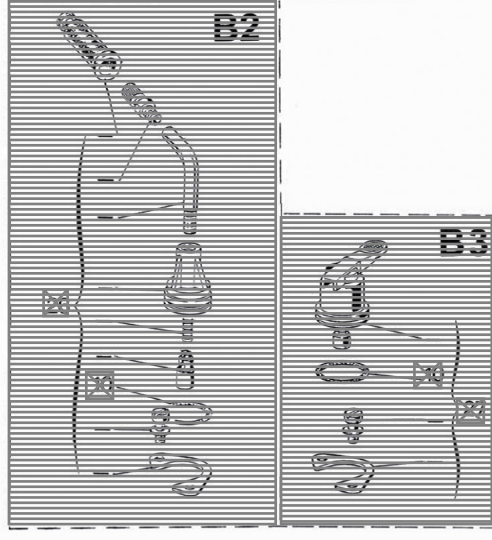
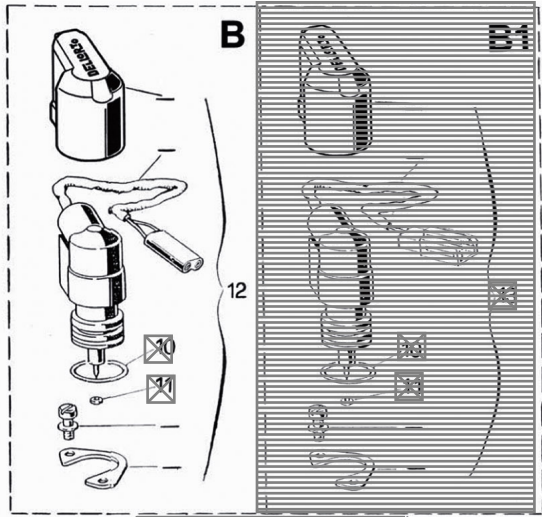
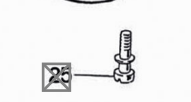
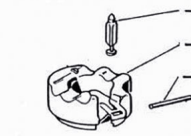
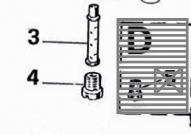
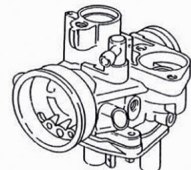
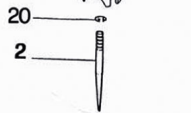
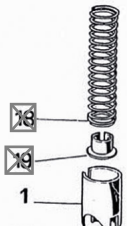
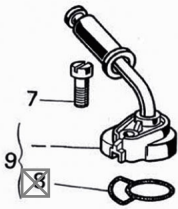
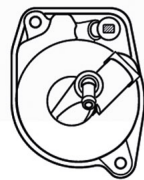

COD. 16354-96

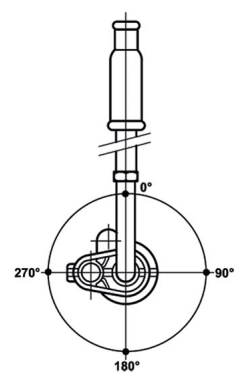
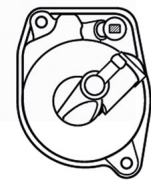

N°	Codice	Descrizione	Qta
0	08411	PHVA 12 QD	1
1	1423040 64	VALVOLA GAS	1
2	1625012 08	SPILLO CONICO A	1
3	14351212 28	POLVERIZZATORE FQ	1
4	06413964 02	GETTO	1
7	0752600 36	VITE	1
9	1456600 53	COPERCHIO VALVOLA	1
12	5307800 78	KIT DISP. AVVIAM. AUTOM.	1
17	5302900 78	KIT VITE REG. VALV. GAS	1
20	0141100 61	MOLLA	1
21	5305300 78	KIT GALLEGGIANTE	1
22	1413000 37	VITE	1
24	1554800 96	VASCHETTA	1
29	1368100 21	ANELLO	1
29	5262200 77	BUSTA GUARNIZIONI	1
33	1370900 36	VITE	2